

Installation Manual

PLEASE READ BEFORE USE AND SAVE.

This handset is an accessory cordless handset, for use with Panasonic base unit KX-TG2970. This installation manual only describes the steps necessary to start up the handset. Please read the base unit operating instructions for further details.

Accessories (included) For extra orders, call 1-800-332-5368.

<input type="checkbox"/> Charger Unit1	<input type="checkbox"/> Battery1
Charger Order No. PQLV30028ZB	Order No. HHR-P402
AC Adaptor Order No. KX-TCA1-G (KX-TCA1)	<input type="checkbox"/> Belt Clip1
<input type="checkbox"/> Handset Cover.1	Order No. PQKE10340Z2
Order No. PQYNTG2970BR	

Installation

Connecting the Charger unit

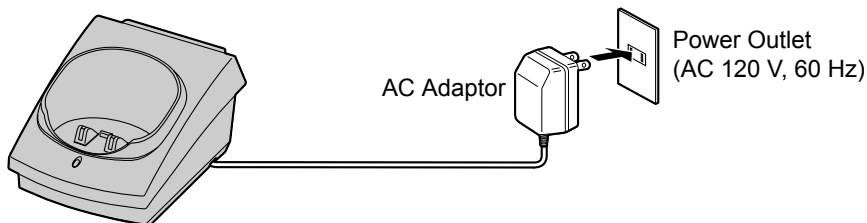

- USE ONLY WITH Panasonic AC ADAPTOR KX-TCA1 (Order No. KX-TCA1-G).
- The AC adaptor must remain connected at all times. (It is normal for the adaptor to feel warm during use.)
- The AC adaptor should be connected to a vertically oriented or floor-mounted AC outlet. Do not connect the AC adaptor to a ceiling-mounted AC outlet, as the weight of the adaptor may cause it to become disconnected.

Installing the battery

Insert the battery (①), and press it down until it snaps into the compartment (②). Close the cover.

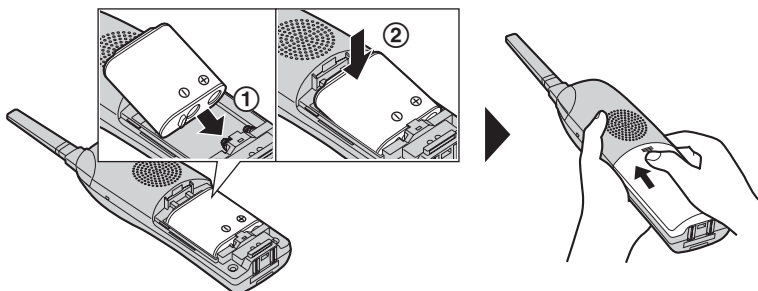



For assistance, please call: 1-800-ADT-ASAP

Charging the battery

Place the cordless handset on the charger and charge for **6 hours** before initial use.

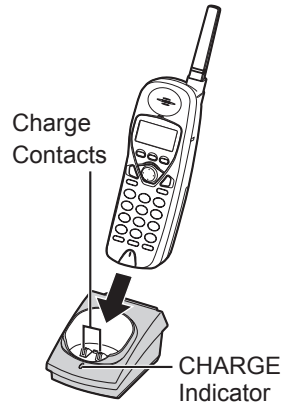
- The unit beeps once, the CHARGE indicator lights and “**Charging**” is displayed.
- When the battery is fully charged, “**Charge completed**” is displayed if there are no new calls in the Caller List.
- Recharge the battery when:
 - “**Recharge battery**” is displayed on the cordless handset,
 - “” flashes, or
 - the cordless handset beeps intermittently while it is in use.



- If the battery has been discharged, the cordless handset will display “**Charge for 6 HRS**” and “” when you place the cordless handset on the charger. The cordless handset will not work unless the battery is charged. Continue charging.

Handset battery information

After your Panasonic battery is fully charged, you can expect the following performance:

Operation	Operating time
While in use (TALK)	Up to 6 hours
While not in use (Standby)	Up to 14 days
While using the Clarity Booster feature	Up to 4 hours

- **Clean the charge contacts of the cordless handset and the charger with a soft, dry cloth once a month. Clean more often if the unit is subject to grease, dust or high humidity.** Otherwise the battery may not charge properly.

Belt Clip

You can hang the cordless handset on your belt or pocket using the included belt clip.

To attach the belt clip

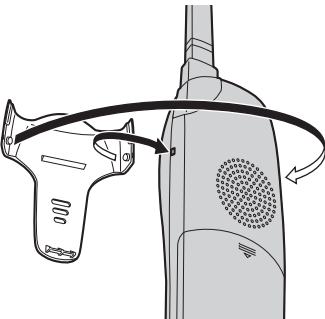

To remove the belt clip

While pressing the top of the clip (A), pull the right edge in the direction of the arrow (B).

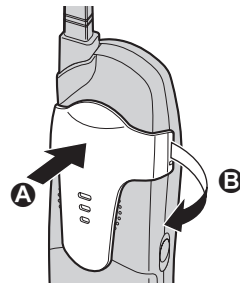

Registration

This cordless handset must be registered to the KX-TG2970 base unit. The cordless handset will be assigned the extension number at registration. Only one cordless handset can be registered at a time. **Charge the battery fully. Make sure the base unit and the other cordless handsets are not being used. Have both the cordless handset and base unit nearby during registration.**

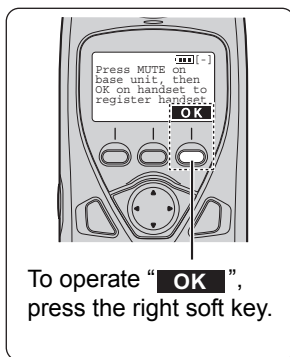
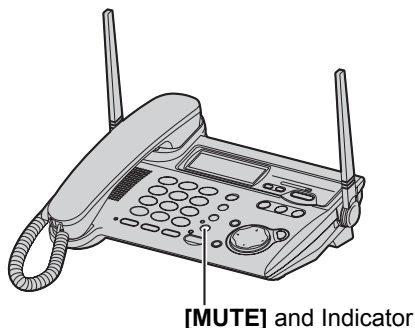

The cordless handset display shows the instructions as shown on the right.

Press MUTE on base unit, then OK on handset to register handset

OK

1 Base unit: Press [MUTE].

- The MUTE indicator flashes. After the MUTE indicator starts flashing, the rest of the procedure must be completed within 1 minute.

2 Cordless Handset:

(1) Press the soft key (**OK**).

(2) Wait until 3 beeps sound and the display shows the new extension number.

- Registration is complete.

Handset Registering

Ex. Extension number 2

Handset [2] Registered

- The registered number "[1]" to "[3]" is shown on the top right of the display.
- You can stop registration by pressing [OFF] on the cordless handset and pressing [MUTE] on the base unit.

To cancel the handset registration, please see your base unit Operating Instructions.

For assistance, please call: 1-800-ADT-ASAP

Optional Headset

Connecting an optional headset to the cordless handset allows hands-free phone conversation. Please use only a Panasonic KX-TCA60, KX-TCA86, KX-TCA88, KX-TCA88HA, KX-TCA91, KX-TCA92 or KX-TCA98 headset. To order, call the accessories telephone number on page 1.

Connecting an optional headset

Open the headset jack cover, and insert the headset plug into the headset jack as shown below.

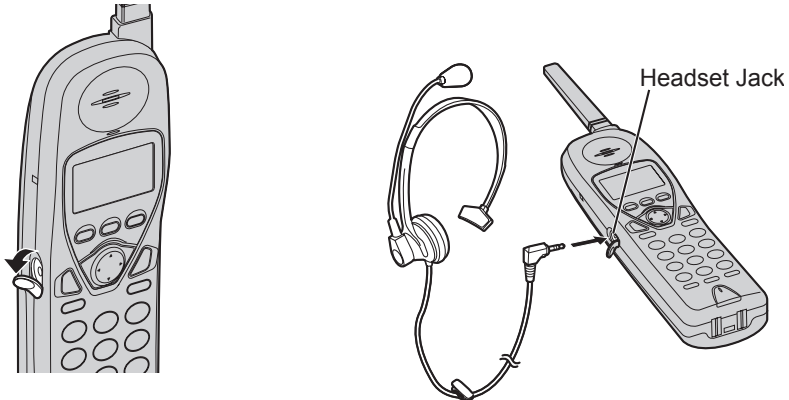

- Headset sold separately. Model shown here is KX-TCA88.

Wall Mounting

The charger can be wall mounted. Connect the AC adaptor. Install screws using the wall template (see below). Mount the charger (1). Slide it down (2), then slide down to the right (3) until it is secured.

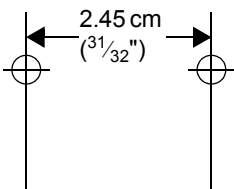
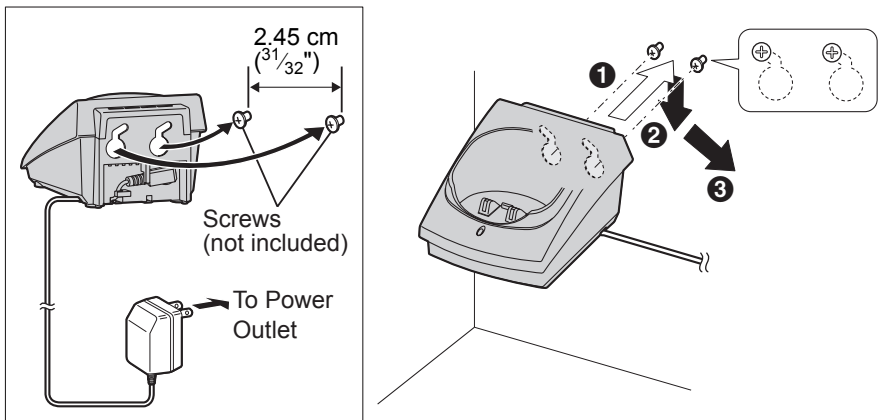

Wall Template

FCC and Other Information

WHEN PROGRAMMING EMERGENCY NUMBERS AND(OR) MAKING TEST CALLS TO EMERGENCY NUMBERS:

1. Remain on the line and briefly explain to the dispatcher the reason for the call.
2. Perform such activities in the off-peak hours, such as early morning or late evenings.

This device complies with Part 15 of the FCC Rules. Operation is subject to the following two conditions: (1) This device may not cause harmful interference, and (2) this device must accept any interference received, including interference that may cause undesired operation.

Privacy of communications may not be ensured when using this phone.

CAUTION:

Any changes or modifications not expressly approved by the party responsible for compliance could void the user's authority to operate this device.

Note:

This equipment has been tested and found to comply with the limits for a Class B digital device, pursuant to Part 15 of the FCC Rules. These limits are designed to provide reasonable protection against harmful interference in a residential installation. This equipment generates, uses, and can radiate radio frequency energy and, if not installed and used in accordance with the instructions, may cause harmful interference to radio communications. However, there is no guarantee that interference will not occur in a particular installation. If this equipment does cause harmful interference to radio or television reception, which can be determined by turning the equipment off and on, the user is encouraged to try to correct the interference by one or more of the following measures:

- Reorient or relocate the receiving antenna.
- Increase the separation between the equipment and receiver.
- Connect the equipment into an outlet on a circuit different from that to which the receiver is connected.
- Consult the dealer or an experienced radio/TV technician for help.

Operating near 2.4 GHz electrical appliances may cause interference. Move away from the electrical appliances.

FCC RF Exposure Warning:

To comply with FCC RF exposure requirements, the handset unit may be carried and operated with only the specific provided belt-clip. Other non-tested belt-clips or similar body-worn accessories may not comply and must be avoided.

This equipment is hearing aid compatible as defined by the FCC in 47 CFR Section 68.316.

When you hold the phone to your ear, noise might be heard in your Hearing Aid. Some Hearing Aids are not adequately shielded from external RF (radio frequency) energy. If noise occurs, use an optional headset accessory or the speakerphone option (if applicable) when using this phone. Consult your audiologist or Hearing Aid manufacturer about the availability of Hearing Aids which provide adequate shielding to RF energy commonly emitted by digital devices.

CAUTION:

To reduce the risk of fire or injury to persons, read and follow these instructions.

1. Use only the battery(ies) specified.
2. Do not dispose of the battery(ies) in a fire. They may explode. Check with local waste management codes for special disposal instructions.
3. Do not open or mutilate the battery(ies). Released electrolyte is corrosive and may cause burns or injury to the eyes or skin. The electrolyte may be toxic if swallowed.
4. Exercise care in handling batteries in order not to short the battery to conductive materials such as rings, bracelets, and keys. The battery and/or conductor may overheat and cause burns.
5. Charge the battery(ies) provided with or identified for use with this product only in accordance with the instructions and limitations specified in this manual.

A nickel metal hydride battery that is recyclable powers the product you have purchased. Please call 1-800-8-BATTERY for information on how to recycle this battery.



WARNING:

TO PREVENT FIRE OR SHOCK HAZARD, DO NOT EXPOSE THIS PRODUCT TO RAIN OR ANY TYPE OF MOISTURE.

- The AC adaptor is used as the main disconnect device, ensure that the AC outlet is located/installed near the unit and is easily accessible.

Copyright:

This material is copyrighted by Panasonic Communications Co., Ltd., and may be reproduced for internal use only. All other reproduction, in whole or in part, is prohibited without the written consent of Panasonic Communications Co., Ltd.

© 2004 Panasonic Communications Co., Ltd. All Rights Reserved.

For your future reference

Serial No. _____

Date of purchase _____

(found on the bottom of the unit)

Name and address of dealer. _____

**If you need assistance with the setup or operation,
please call 1-800-ADT-ASAP**

Panasonic World Wide Web address: <http://www.panasonic.com>
for customers in the USA or Puerto Rico

For customer inquiries:

- Read this Installation Manual or your base unit Operating Instructions.
- Please call 1-800-ADT-ASAP

**Panasonic Consumer Electronics Company,
Division of Matsushita Electric Corporation of America**
One Panasonic Way, Secaucus, New Jersey 07094

**Panasonic Sales Company,
Division of Matsushita Electric of Puerto Rico, Inc.**
Ave. 65 de Infantería, Km. 9.5, San Gabriel Industrial Park
Carolina, Puerto Rico 00985

Manual de instalación

LÉALO ANTES DE LA UTILIZACIÓN Y LUEGO GUÁRDELO.

Esta unidad portátil es una unidad inalámbrica accesoria utilizable con la unidad base KX-TG2970. Este manual de instalación sólo describe los pasos necesarios para poner en funcionamiento la unidad portátil. Lea las instrucciones de funcionamiento de la unidad base para más detalles.

Accesorios (incluidos) Para más pedidos, llame al 1-800-332-5368.

- | | |
|--|---|
| <input type="checkbox"/> Unidad de carga1 | <input type="checkbox"/> Batería1 |
| Nº. de pedido de la unidad de carga:
PQLV30028ZB | Nº. de pedido: HHR-P402 |
| Nº. de pedido del adaptador de CA:
KX-TCA1-G (KX-TCA1) | <input type="checkbox"/> Presilla para el cinturón1 |
| <input type="checkbox"/> Cubierta de la unidad portátil.1 | Nº. de pedido: PQKE10340Z2 |
| Nº. de pedido: PQYNTG2970BR | |

Instalación

Conecte la unidad de carga

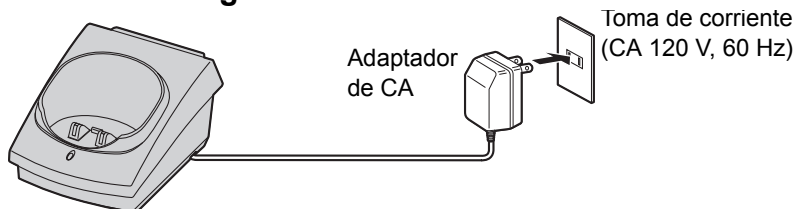

- USAR SÓLO CON EL ADAPTADOR DE CA KX-TCA1 (Nº. de pedido: KX-TCA1-G) de Panasonic.
- El adaptador de CA debe permanecer conectado en todo momento. (Es normal que el adaptador se caliente durante su uso.)

Instalación de la batería

Inserte la batería (1), y empújela hacia abajo hasta que encaje con un chasquido en el compartimento (2). Cierre la cubierta.

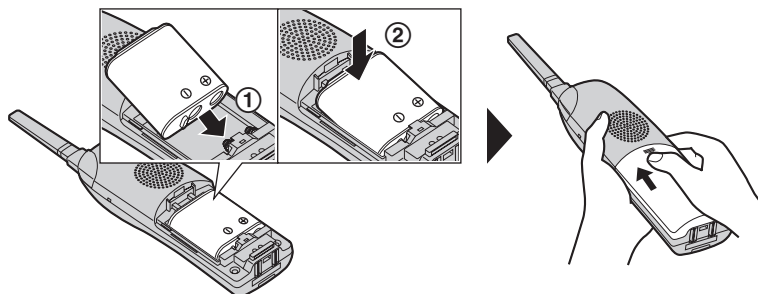

Carga de la batería

Coloque la unidad portátil en la unidad de carga y cárguela durante **6 horas** antes de empezar a usarla.

- La unidad emite un pitido, el indicador CHARGE se ilumina, y “**Charging**” aparece en pantalla.
- Cuando la batería está completamente cargada, aparece “**Charge completed**” si no hay llamadas nuevas en la lista de personas que llaman.
- Recargue la batería cuando:
 - “**Recharge battery**” aparece en la unidad portátil,
 - “” parpadee, o
 - la unidad portátil emita pitidos intermitentes mientras está en uso.



- Si la batería se ha descargado, la unidad portátil mostrará en pantalla “**Charge for 6 HRS**” y “” cuando coloque la unidad portátil sobre la unidad de carga. La unidad portátil no funcionará a no ser que la batería esté cargada. Siga cargando.

Información sobre la batería de la unidad portátil

Una vez que la batería de Panasonic está completamente cargada, puede esperar el siguiente rendimiento:

Operación	Tiempo de operación
En uso (HABLAR)	Hasta 6 horas
En espera (Espera)	Hasta 14 días
Mientras está en uso la función de refuerzo de la recepción	Hasta 4 horas

- **Limpe los contactos de carga de la unidad portátil y de la unidad de carga con un paño suave y seco una vez al mes. Límpielos más a menudo si la unidad está sometida a grasa, polvo o a humedad de nivel alta.** De lo contrario, puede que la batería no se cargue correctamente.

Presilla para el cinturón

La unidad portátil se puede colgar en el cinturón o en el bolsillo por medio de la presilla para el cinturón suministrada.

Para poner la presilla para el cinturón

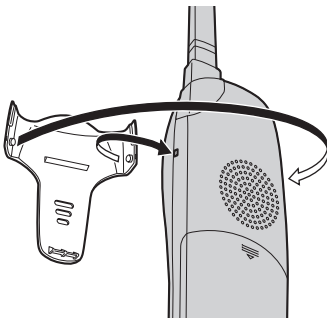

Para quitar la presilla para el cinturón

A la vez que presiona la parte superior de la presilla (A), tire del borde derecho en dirección de la flecha (B).

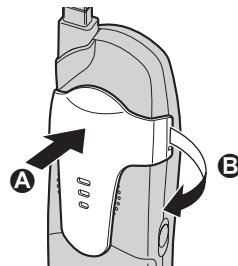

Registro

Esta unidad portátil inalámbrica debe registrarse en una unidad base KX-TG2970. A la unidad portátil se le asignará su número de extensión al registrarla. Sólo se puede registrar una unidad portátil cada vez. **Cargue la batería completamente. Asegúrese de que la unidad base y las demás unidades portátiles no se están utilizando. Tenga a mano tanto la unidad portátil como la unidad base durante el registro.**

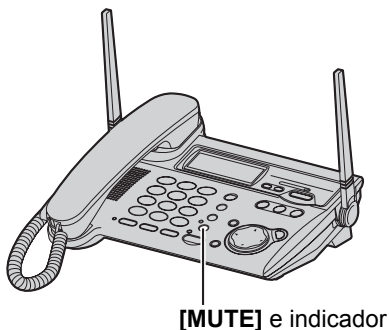

La pantalla de la unidad portátil muestra las instrucciones tal y como aparecen a la derecha.

Press MUTE on base unit, then OK on handset to register handset

OK

1 Unidad base: Presione [MUTE].

- El indicador MUTE parpadea. Después de que el indicador MUTE empiece a parpadear, el resto del procedimiento debe completarse antes de que pase 1 minuto.

2 Unidad portátil:

(1) Presione la tecla blanda (**OK**).

(2) Espere hasta que suene tres pitidos largos y que la pantalla muestre el nuevo número de extensión.

- El registro ha finalizado.

Handset [1]
Registering

Ej. Número de extensión 2

Handset [2]
Registered

- El número registrado "[1]" a "[3]" aparece en la esquina superior derecha de la pantalla.
- Puede detener el proceso de registro presionando **OFF** en la unidad portátil y presionando **MUTE** en la unidad base.

Para cancelar el registro de la unidad portátil, consulte las instrucciones de funcionamiento de la unidad base.

Auricular opcional

La conexión de un auricular opcional a la unidad portátil permite conversar telefónicamente con las manos libres. Por favor, utilice solamente un auricular KX-TCA60, KX-TCA86, KX-TCA88, KX-TCA88HA, KX-TCA91, KX-TCA92 o KX-TCA98 de Panasonic. Para hacer un pedido, llame al número de teléfono de accesorios indicado en la página 1.

Conexión de un auricular opcional

Abra la cubierta de la toma del auricular, e inserte allí la clavija del auricular como se indica abajo.

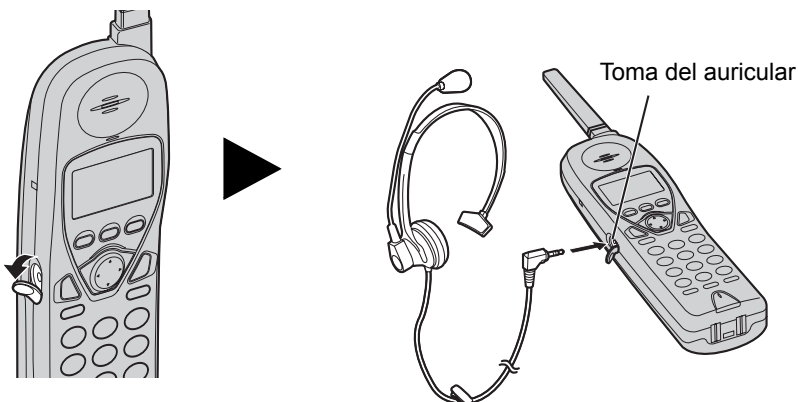

- El auricular se vende por separado. El modelo mostrado aquí es un KX-TCA88.

Montaje en pared

La unidad de carga se puede montar en la pared. Conecte el adaptador de CA. Introduzca los tornillos usando la plantilla de pared (ver abajo). Monte la unidad de carga (1). Deslícela hacia abajo (2), luego deslícela hacia abajo y a la derecha (3) hasta que quede bien sujeta.

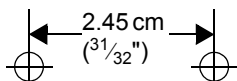
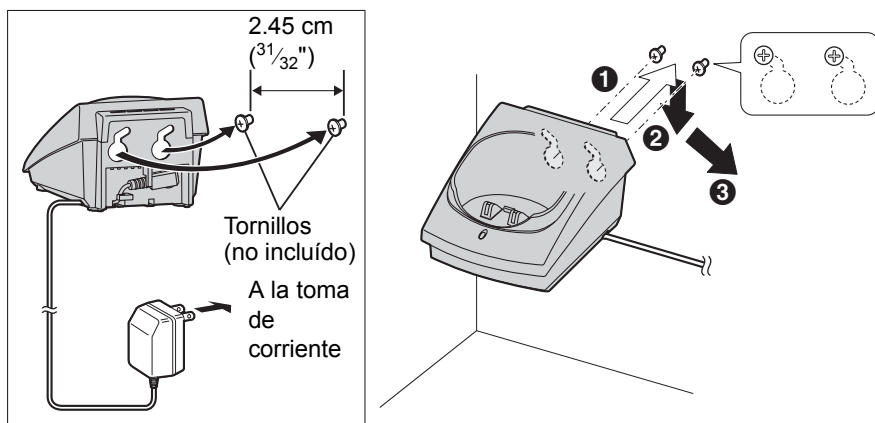

Plantilla de pared

PANASONIC CONSUMER
ELECTRONICS COMPANY, DIVISION
OF MATSUSHITA ELECTRIC
CORPORATION OF AMERICA
One Panasonic Way
Secaucus, New Jersey 07094

PANASONIC SALES COMPANY,
DIVISION OF MATSUSHITA
ELECTRIC OF PUERTO RICO, INC.,
Ave. 65 de Infanteria, Km. 9.5
San Gabriel Industrial Park
Carolina, Puerto Rico 00985

Panasonic Telephone Products Limited Warranty

Limited Warranty Coverage

If your product does not work properly because of a defect in materials or workmanship, Panasonic Consumer Electronics Company or Panasonic Sales Company (collectively referred to as "the warrantor") will, for the length of the period indicated on the chart below, which starts with the date of original purchase ("Limited Warranty period"), at its option either (a) repair your product with new or refurbished parts, or (b) replace it with a new or a refurbished product. The decision to repair or replace will be made by the warrantor.

Parts	Labor
One (1) Year	One (1) Year

During the "Labor" Limited Warranty period there will be no charge for labor. During the "Parts" Limited Warranty period, there will be no charge for parts. You must mail-in your product during the Limited Warranty period. This Limited Warranty excludes both parts and labor for batteries, antennas, and cosmetic parts (cabinet). This Limited Warranty only applies to products purchased and serviced in the United States or Puerto Rico. This Limited Warranty is extended only to the original purchaser and only covers products purchased as new.

Mail-In Service

For assistance in the continental U.S.A. in obtaining repairs please ship the product to:

**Panasonic Services Company Customer Servicenter
Suite B 4900 George McVay Drive McAllen, TX 78503**

For assistance in Puerto Rico call Panasonic Sales Company (787)-750-4300 or fax (787)-768-2910.

For Limited Warranty service for headsets if a headset is included with this product please call Panasonic Call Center at 1-800-211-PANA (7262).

When shipping the unit carefully pack, include all accessories, and send it prepaid, adequately insured and preferably in the original carton. Include a letter detailing the complaint and provide a day time phone number where you can be reached.

IF REPAIR IS NEEDED DURING THE LIMITED WARRANTY PERIOD THE PURCHASER WILL BE REQUIRED TO FURNISH A SALES RECEIPT/PROOF OF PURCHASE INDICATING DATE OF PURCHASE, AMOUNT PAID AND PLACE OF PURCHASE. CUSTOMER WILL BE CHARGED FOR THE REPAIR OF ANY UNIT RECEIVED WITHOUT SUCH PROOF OF PURCHASE.

Limited Warranty Limits And Exclusions

This Limited Warranty ONLY COVERS failures due to defects in materials or workmanship, and DOES NOT COVER normal wear and tear or cosmetic damage. The Limited Warranty ALSO DOES NOT COVER damages which occurred in shipment, or failures which are caused by products not supplied by the warrantor, or failures which result from accidents, misuse, abuse, neglect, mishandling, misapplication, alteration, faulty installation, set-up adjustments, misadjustment of consumer controls, improper maintenance, power line surge, lightning damage, modification, introduction of sand, humidity or liquids, commercial use such as hotel, office, restaurant, or other business or rental use of the product, or service by anyone other than a Factory Servicenter or other Authorized Servicer, or damage that is attributable to acts of God.

THERE ARE NO EXPRESS WARRANTIES EXCEPT AS LISTED UNDER "LIMITED WARRANTY COVERAGE". THE WARRANTOR IS NOT LIABLE FOR INCIDENTAL OR CONSEQUENTIAL DAMAGES RESULTING FROM THE USE OF THIS PRODUCT, OR ARISING OUT OF ANY BREACH OF THIS LIMITED WARRANTY. (As examples, this excludes damages for lost time, lost calls or messages, cost of having someone remove or re-install an installed unit if applicable, travel to and from the servicer. The items listed are not exclusive, but are for illustration only.) ALL EXPRESS AND IMPLIED WARRANTIES, INCLUDING THE WARRANTY OF MERCHANTABILITY, ARE LIMITED TO THE PERIOD OF THE LIMITED WARRANTY.

For ADT Security System Customers, please call 1-800-ADT-ASAP

Some states do not allow the exclusion or limitation of incidental or consequential damages, or limitations on how long an implied warranty lasts, so the exclusions may not apply to you. This Limited Warranty gives you specific legal rights and you may also have other rights which vary from state to state. If a problem with this product develops during or after the Limited Warranty period, you may contact your dealer or Servicenter. If the problem is not handled to your satisfaction, then write to the warrantor's Consumer Affairs Department at the addresses listed for the warrantor.

PARTS AND SERVICE, WHICH ARE NOT COVERED BY THIS LIMITED WARRANTY, ARE YOUR RESPONSIBILITY.

Customer Services Directory

Obtain Product Information and Operating Assistance; locate your nearest Dealer or Servicenter; purchase Parts and Accessories; or make Customer Service and Literature requests by visiting our Web Site at:

<http://www.panasonic.com/support>

or, contact us via the web at:

<http://www.panasonic.com/contactinfo>

You may also contact us directly at: 1-800-211-PANA (7262),
Monday-Friday 9 am-9 pm; Saturday-Sunday 10 am-7 pm, EST.

For hearing or speech impaired TTY users, TTY : 1-877-833-8855

Accessory Purchases

Purchase Parts, Accessories and Instruction Books online for all Panasonic Products by visiting our Web Site at:

<http://www.pasc.panasonic.com>

or, send your request by E-mail to:

npcparts@us.panasonic.com

You may also contact us directly at:

1-800-332-5368 (Phone) 1-800-237-9080 (Fax Only)

(Monday - Friday 9 am to 8 pm, EST.)

Panasonic Services Company

20421 84th Avenue South, Kent, WA 98032

(We Accept Visa, MasterCard, Discover Card, American Express,
and Personal Checks)

For hearing or speech impaired TTY users, TTY : 1-866-605-1277

Service in Puerto Rico

***Matsushita Electric of Puerto Rico, Inc. Panasonic Sales Company
Factory Servicenter:***

***Ave. 65 de Infantería, Km. 9.5, San Gabriel Industrial Park,
Carolina, Puerto Rico 00985***

Phone (787)750-4300, Fax (787)768-2910

For ADT Security System Customers, please call 1-800-ADT-ASAP